

iQ Optima

HOMOGENOUS COMPACT VINYL



Moving Nuances

SUBTLE COLOURS THAT NURTURE WELLBEING

 **Tarkett**

iQ Optima

Moving nuances



The new collection

Nurture wellbeing using the organic lines, subtle tones, and countless combinations of the new moving nuances collection.

With over 40 years as a bestseller and 100 million square metres sold, our iQ Optima line now features new designs and an expanded palette of colours. Inspired by the soft washes and shifting translucent, opaque quality of watercolour, the range adds to the delicate tones already found in the collection.

iQ Optima has a directional effect, exclusive to Tarkett, and is now available in 3 designs and 55 colours.

Functionality is foundational to what we offer, and iQ Optima is no exception. It is renowned

for its unique iQ dry-buffing surface restoration, a simple and effective flooring maintenance procedure, that extends its lifespan and provides unbeatable durability.

Specially designed to be used in combination with our iQ Granit and iQ Eminent lines, iQ Optima can also be aesthetically and technically paired with our iQ technical ranges which have non-slip, conductive, and dissipative characteristics.

Produced in Sweden, the range is globally recognised for sustainable performance, made from responsible materials and recyclable with our ReStart® programme (installation off-cuts and post-use).

iQ Optima: making history.

Performance that lasts a lifetime

Homogeneous vinyl was conceived as a concept in Sweden over 60 years ago and remains a mainstay for high traffic areas in educational and health care settings to this day. Its versatility and enduring qualities have made it an iconic floor that delivers both long-lasting design and technical functionality.



Unique directional modern design
Revitalised contemporary patterns

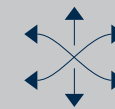

True multifunctionality
Adapts to your needs



Best-in-class durability
With iQ dry-buffing surface restoration



Sustainability at the heart
Recyclable post-use



iQ Optima Original Medium Cool Grey | 3242 762
iQ Optima Blend Blue | 3242 993

iQ Optima collection: a new patterning story

Crafted by our designers in Sweden iQ Optima is inspired by natural travertine limestone, and so is distinguished by its directional pattern, but its calm, watercolour-like washes are what sets it apart. We want to offer the opportunity to play with the directional effect and build spaces that can inspire.

Soothing, welcoming, and refreshing iQ Optima is designed for the next generation of social spaces.



iQ Optima Original Medium Cool Grey | 3242 762
iQ Optima Blend Blue | 3242 993

iQ Optima collection

There are three patterns in the collection, all of which use translucent chips for a 3D watercolour effect. The **Mono** design is the least contrasting and works brilliantly as a dementia friendly option. **Blend** uses contrasting colour tones for a subtle yet striking pattern, while **Original** has lightly differing tones for a watercolour-like effect. The designs are completely unique to Tarkett, and were chosen for their understated, subtle nature, ideal for use across large general areas.



OXID

Reddish tones and cold beige neutrals.

The first of four colour themes is a carefully selected group of colours and neutrals linked to the red spectra of nature. The palette has four colour hues, red, coral, brick orange, and dark old brick, which are all easy to combine with the calm and humble tones of clay and beige neutrals. This palette brings harmony and depth, perfect for creating dynamic and nuanced spaces.

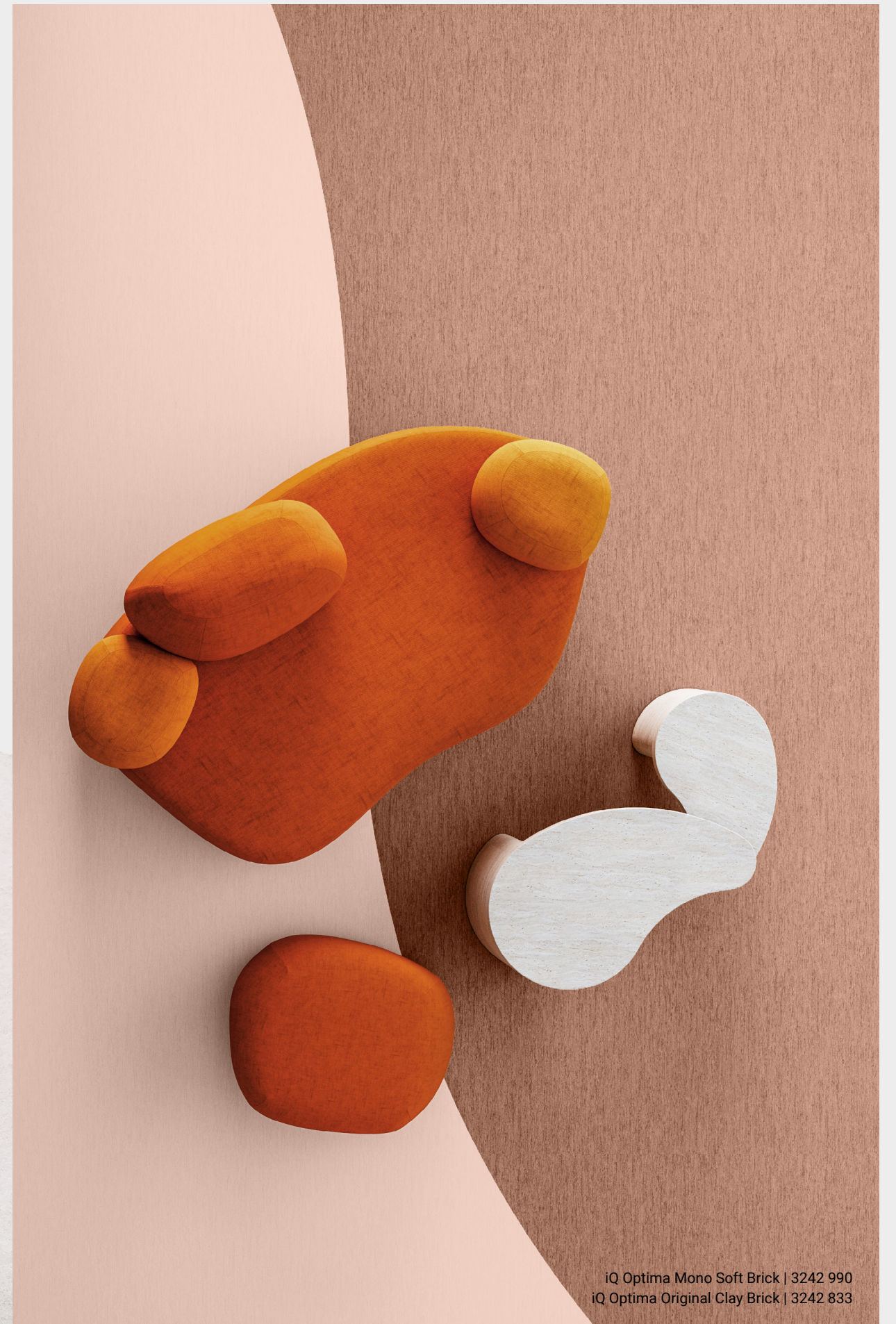

iQ Optima Mono Soft Brick | 3242 990
iQ Optima Original Clay Brick | 3242 833

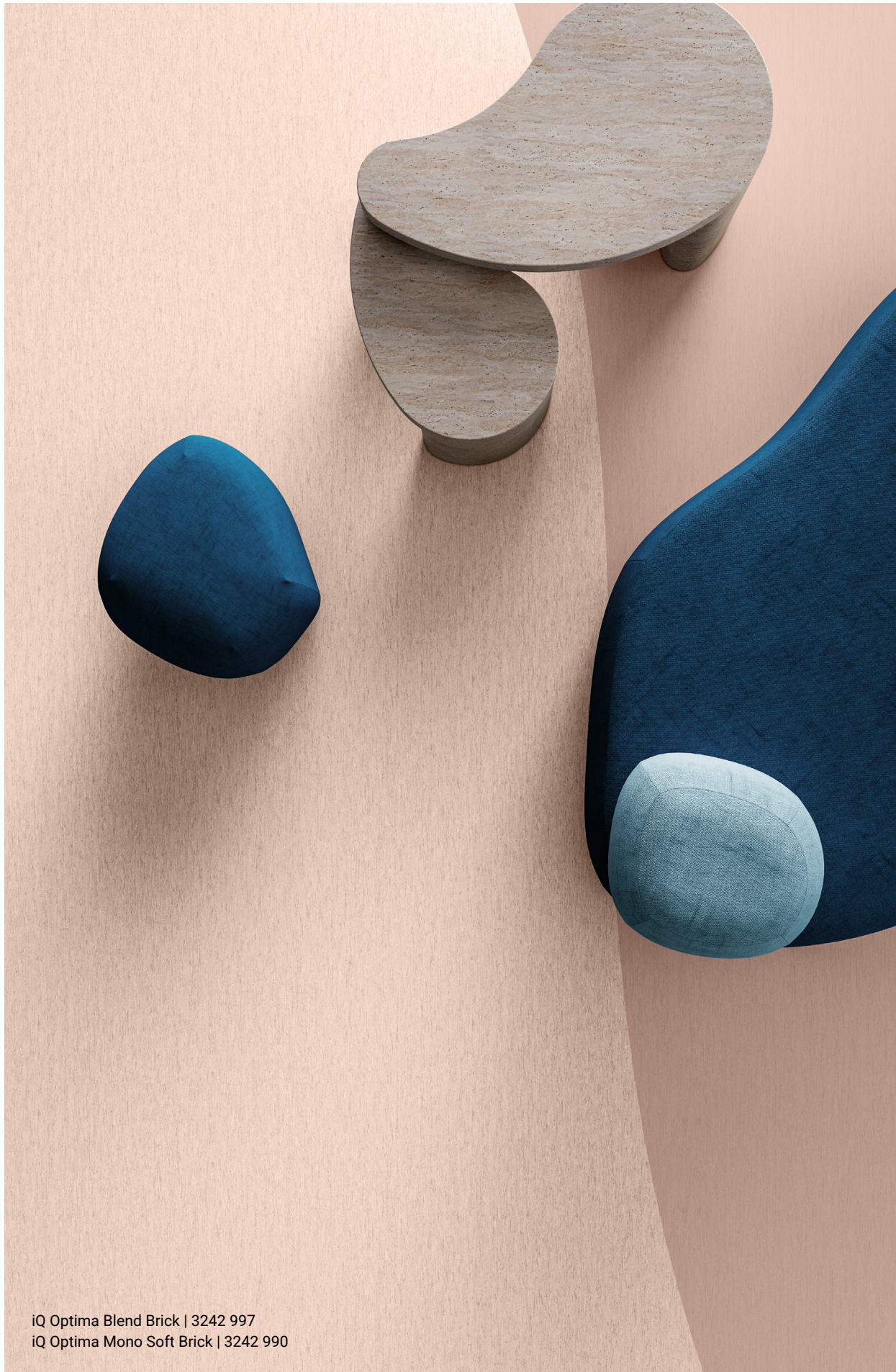

iQ Optima Blend Brick | 3242 997
iQ Optima Mono Soft Brick | 3242 990

iQ Optima **Blend Brick** | 3242 997



SCALE 1:6



SCALE 1:2

iQ Optima **Mono Soft Brick** | 3242 990



SCALE 1:6

SCALE 1:2

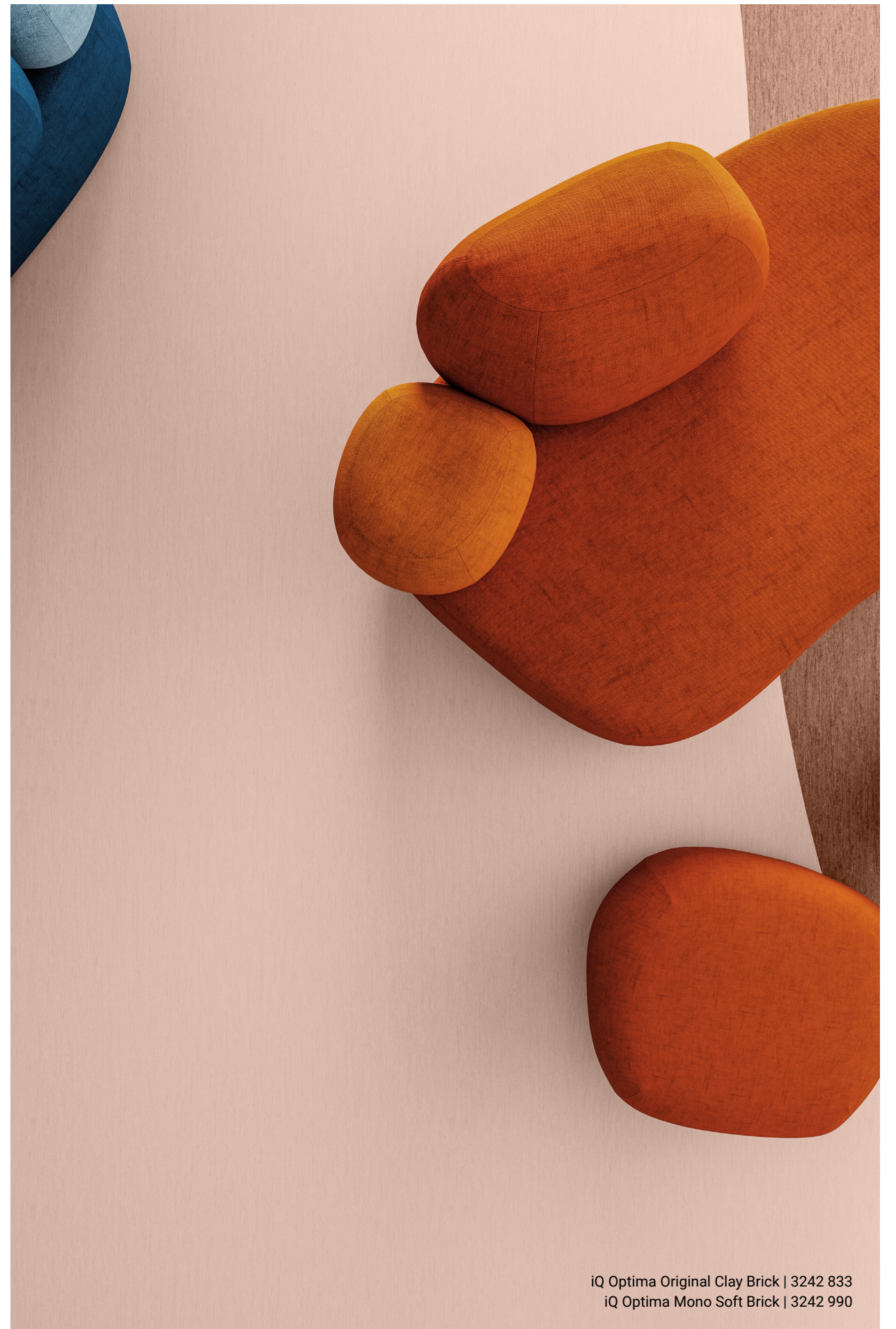

iQ Optima Original Clay Brick | 3242 833
iQ Optima Mono Soft Brick | 3242 990



iQ Optima Mono Soft Brick | 3242 990
iQ Optima Original Clay Brick | 3242 833

iQ Optima **Original Clay Brick** | 3242 833



SCALE 1:6

SCALE 1:2



ARGIL

Yellowish tones and warm beige neutrals.

This colour theme is reminiscent of the warmth of nature and has a fresh brightness. The palette has four colours, yellow, light yellow, light olive green, and olive green, which work well with the warm, earthy tones of sand and beige neutrals. A fine-tuned selection that can create revitalising and welcoming spaces.



iQ Optima Original Sand | 3242 822
iQ Optima Original Yellow | 3242 834
iQ Optima Original Warm Sand | 3242 823

iQ Optima **Original Warm Sand** | 3242 823



SCALE 1:2



iQ Optima Original Yellow | 3242 834
iQ Optima Original Warm Sand | 3242 823



iQ Optima Original Sand | 3242 822
iQ Optima Original Yellow | 3242 834

iQ Optima **Original Sand** | 3242 822



SCALE 1:6

SCALE 1:2



iQ Optima **Original Yellow** | 3242 834

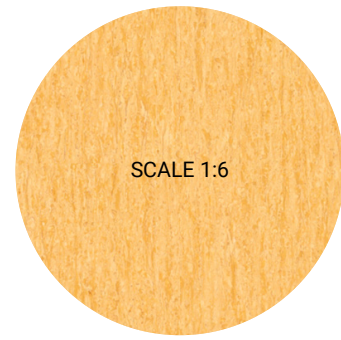

SCALE 1:6

SCALE 1:2

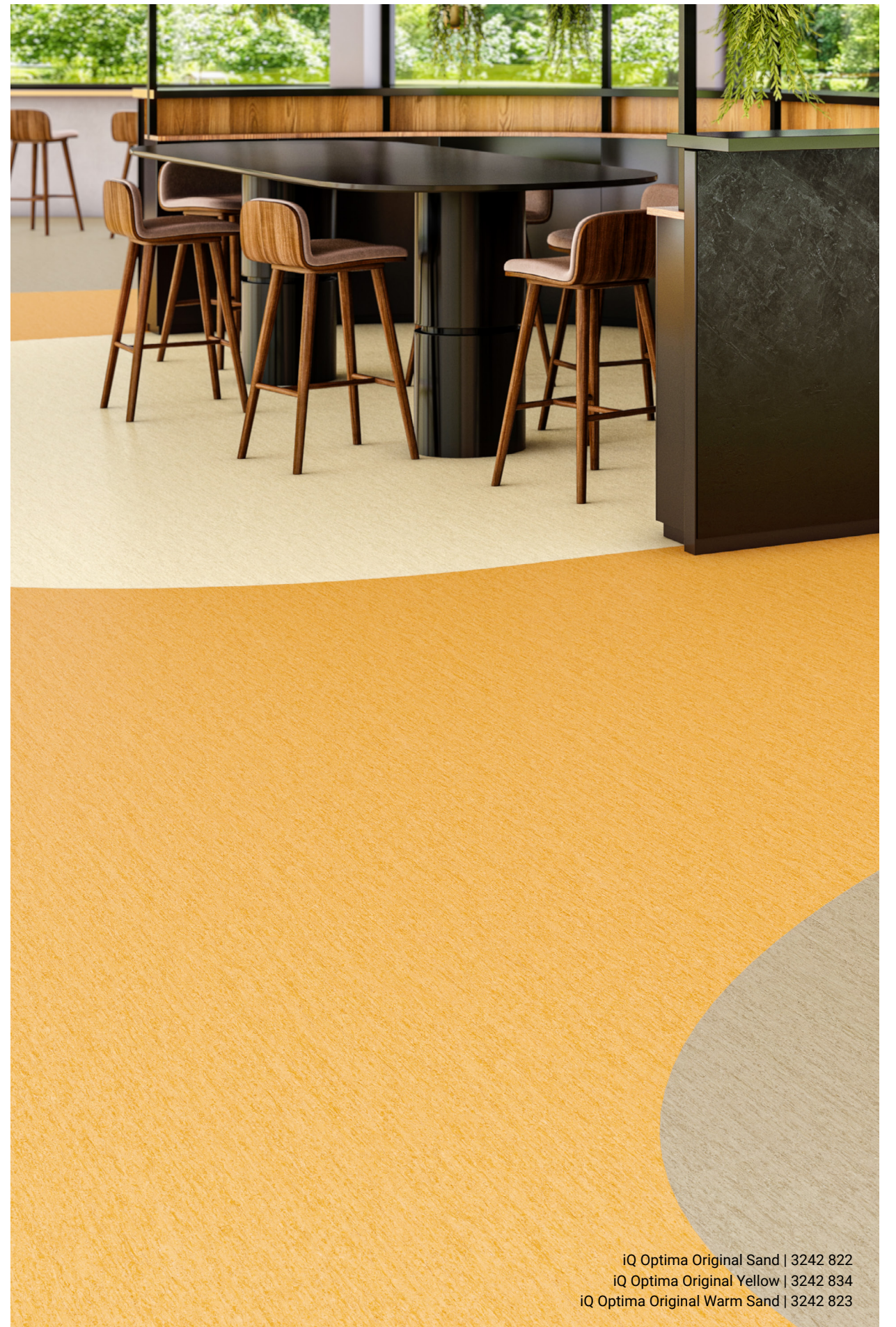

iQ Optima Original Sand | 3242 822
iQ Optima Original Yellow | 3242 834
iQ Optima Original Warm Sand | 3242 823

LICHEN

Greenish tones and warm grey neutrals.

This colour theme reflects the vital and lively side of the nature, full of refreshing energy. The palette has four colour tones, green, light green, grey green, and light aqua which work harmoniously with warm grey neutrals and toned-down colours. A well-balanced selection for creating inspiring and contemporary spaces.



iQ Optima Green Grey | 3242 841
iQ Optima Original Light Grey White | 3242 760
iQ Optima Light Aqua | 3242 848

iQ Optima **Original Green Grey** | 3242 841



SCALE 1:2



iQ Optima Green Grey | 3242 841
iQ Optima Original Light Grey White | 3242 760



iQ Optima Original Light Grey White | 3242 760
iQ Optima Green Grey | 3242 841

iQ Optima **Original Light Grey White** | 3242 760



SCALE 1:6



SCALE 1:2

iQ Optima **Original Light Aqua** | 3242 848



SCALE 1:2



iQ Optima Light Aqua | 3242 848
iQ Optima Original Light Grey White | 3242 760

BASALT

Blueish tones and cold grey neutrals.

The final colour theme is linked to the fresh, cool, and dark spectra of nature. The palette has four colour tones, blue, light blue, medium blue, and dark blue which combine beautifully with cool grey neutrals. An essential selection for creating contrasting, bold, and inviting spaces.

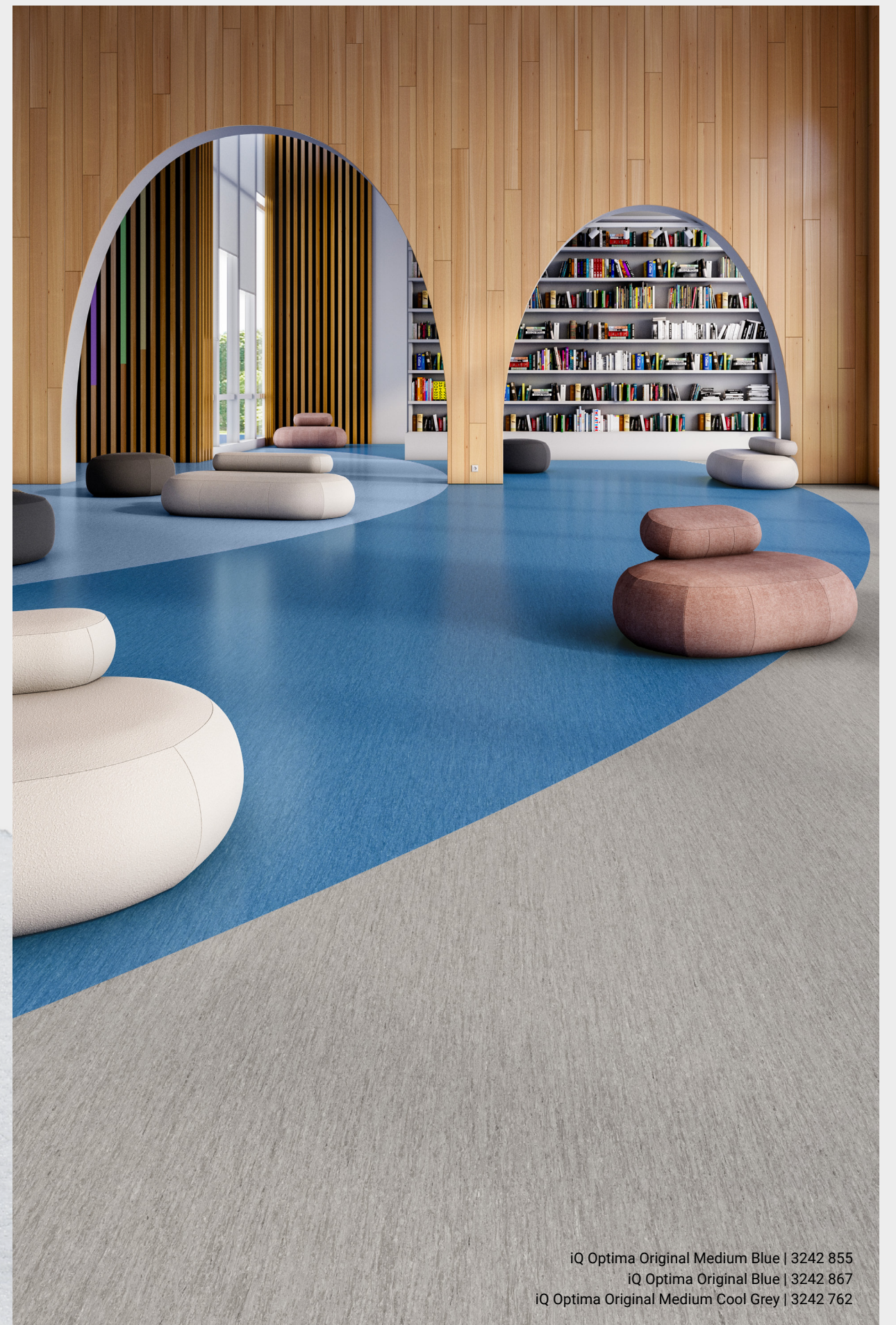
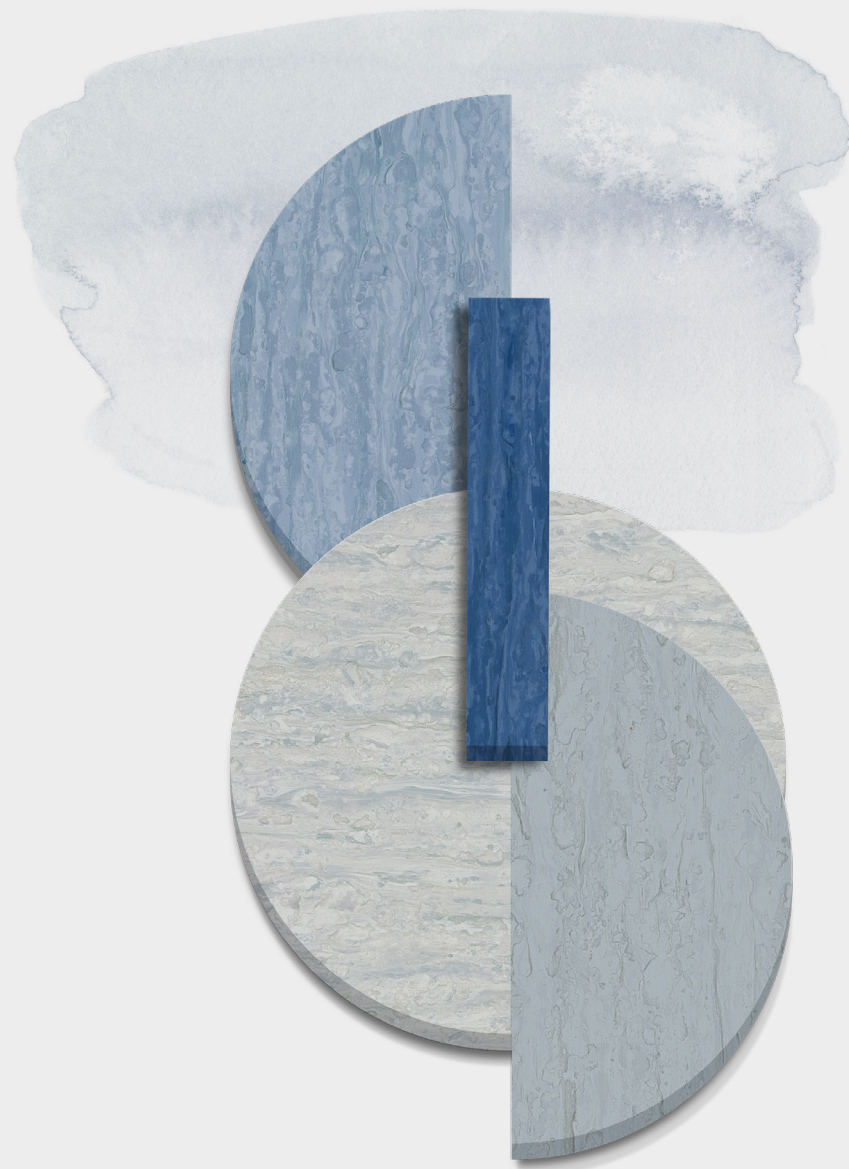

iQ Optima Original Medium Blue | 3242 855
iQ Optima Original Blue | 3242 867
iQ Optima Original Medium Cool Grey | 3242 762

iQ Optima **Original Blue** | 3242 867



SCALE 1:2

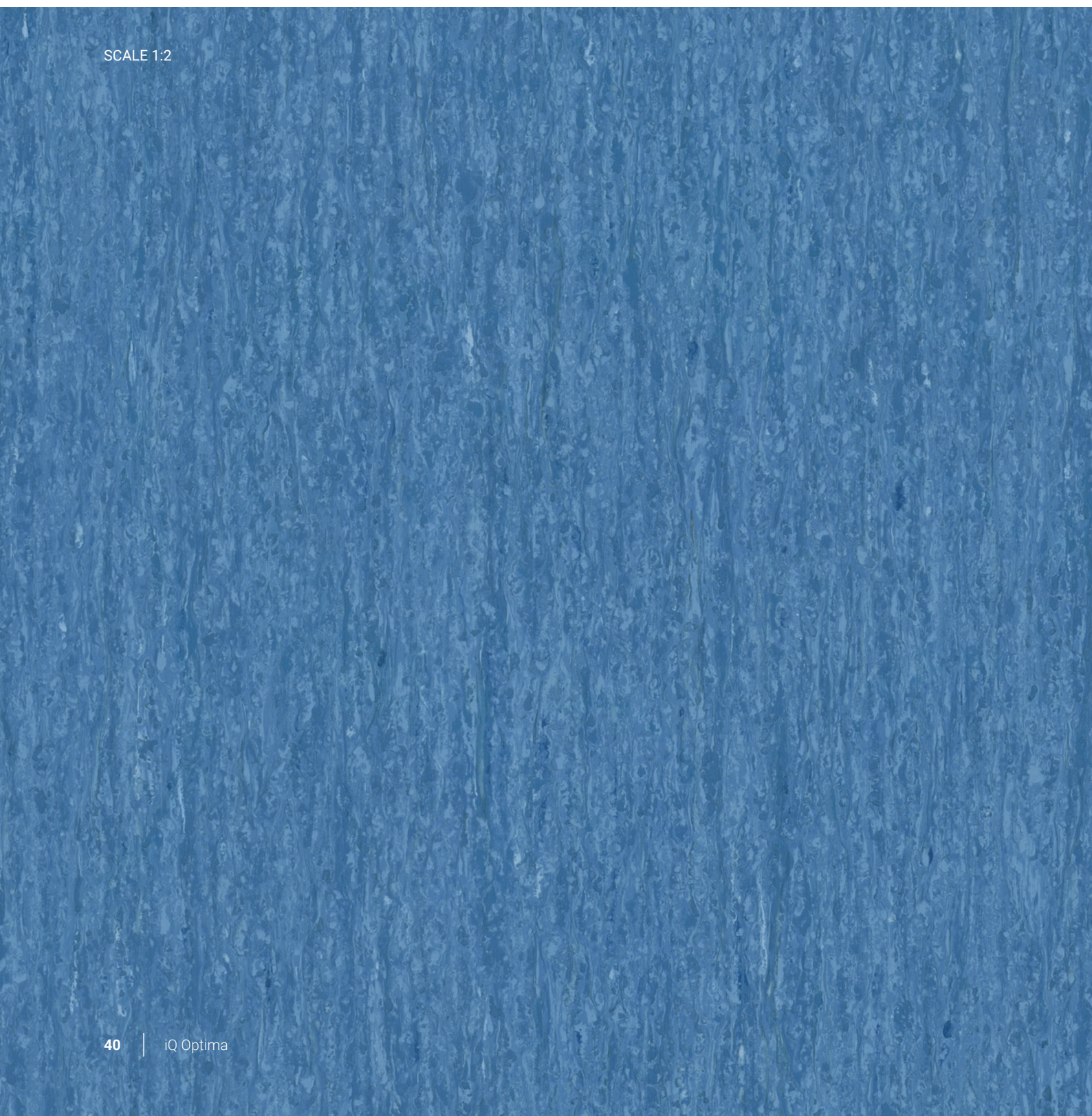

iQ Optima Original Medium Blue | 3242 855
iQ Optima Original Blue | 3242 867

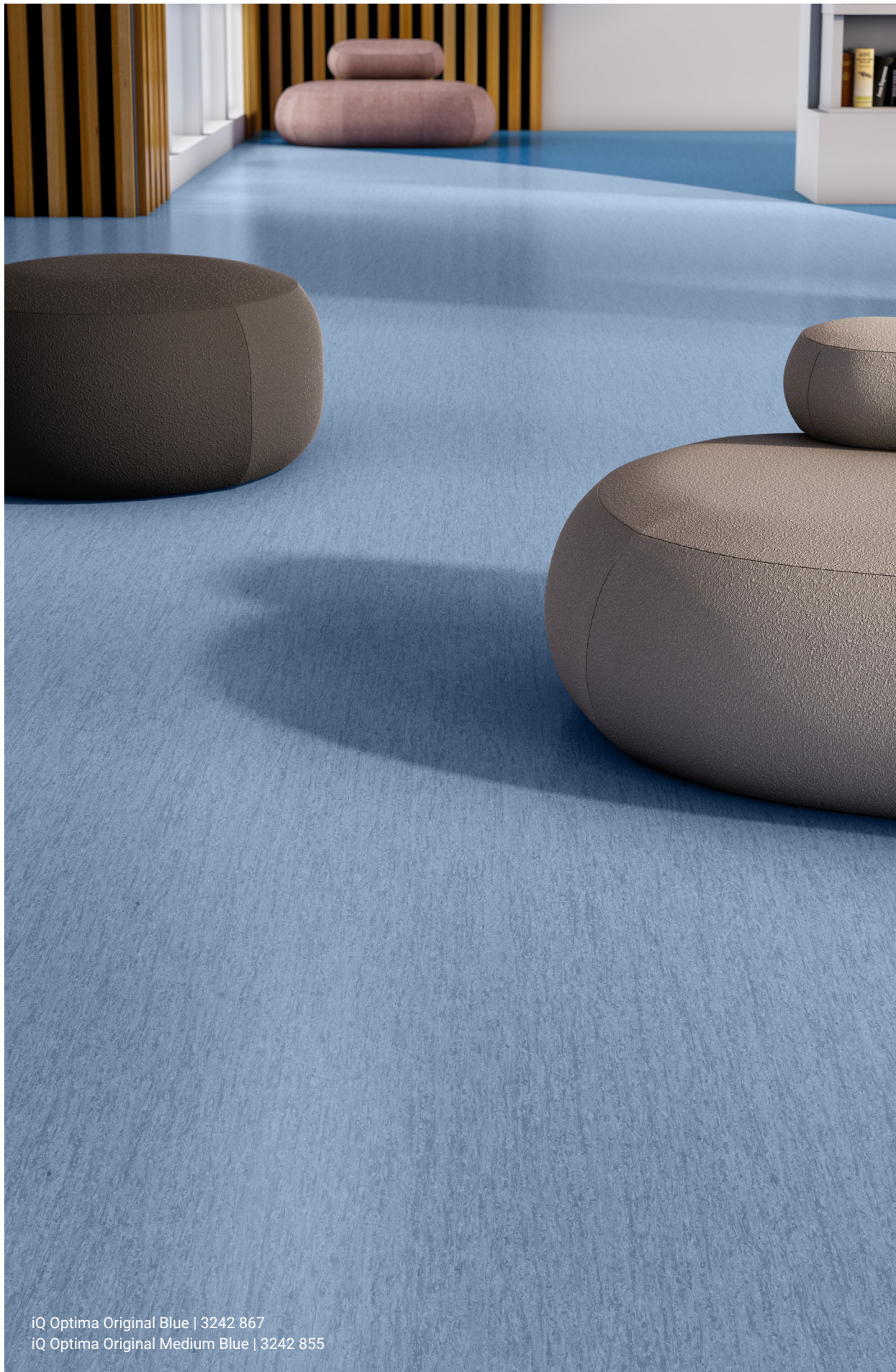

iQ Optima Original Blue | 3242 867
iQ Optima Original Medium Blue | 3242 855

iQ Optima **Original Medium Blue** | 3242 855



SCALE 1:6



SCALE 1:2

iQ Optima **Original Medium Cool Grey** | 3242 762



SCALE 1:2

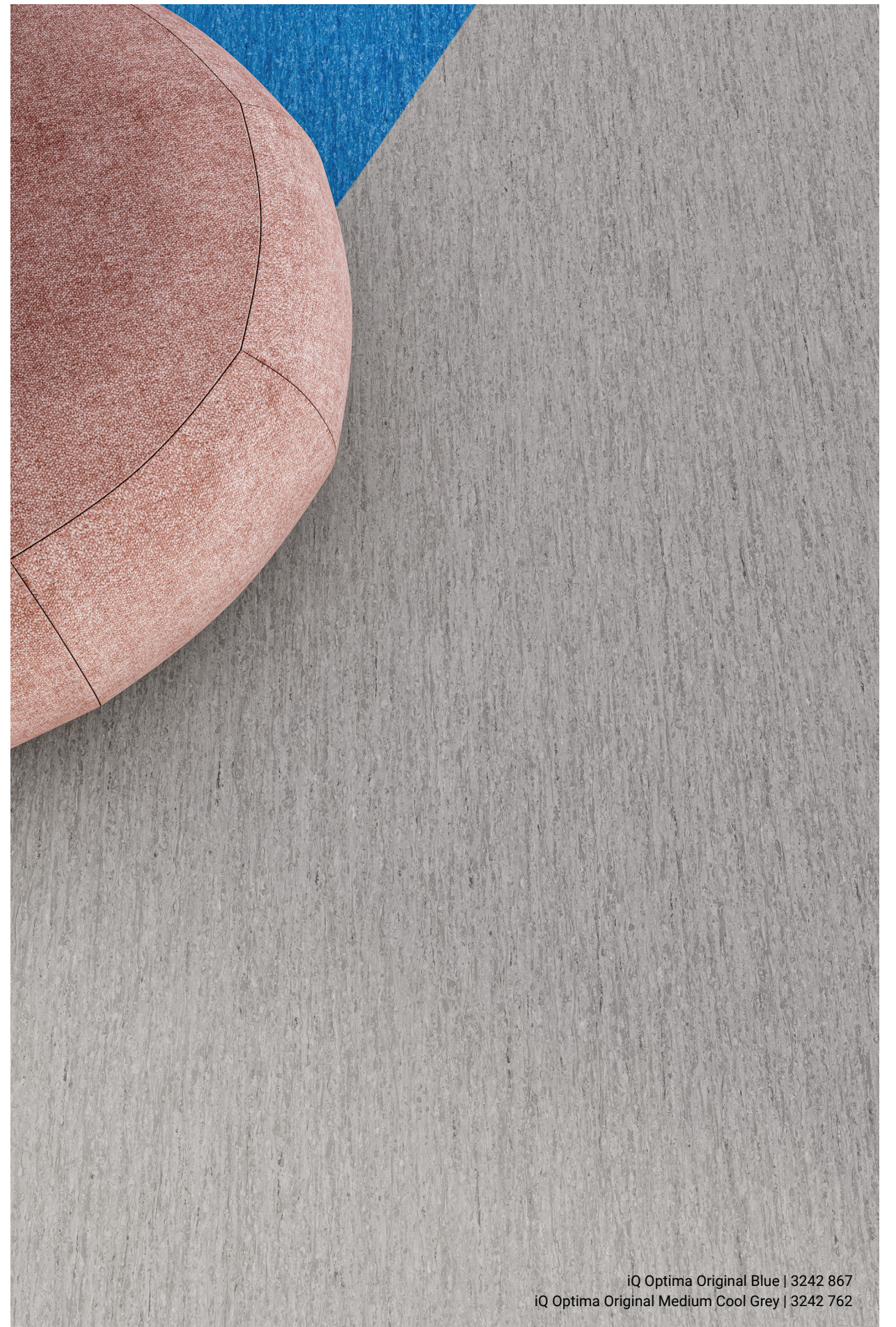

iQ Optima Original Blue | 3242 867
iQ Optima Original Medium Cool Grey | 3242 762

The background is a complex, layered composition of organic, wavy shapes. The colors include various shades of green, blue, orange, and purple. The textures vary, with some areas appearing smooth and others having a speckled or marbled effect, similar to terrazzo or stone. The shapes are layered, creating a sense of depth and movement.

iQ Collection

HARMONY OF COLOURS



The moving nuances collection has been organised to reflect our wider range of iQ flooring. Each of the four specially chosen colour palettes (Oxid, Argil, Lichen, Basalt) can be paired across our iQ Granit and Eminent Ranges to create harmonious spaces.

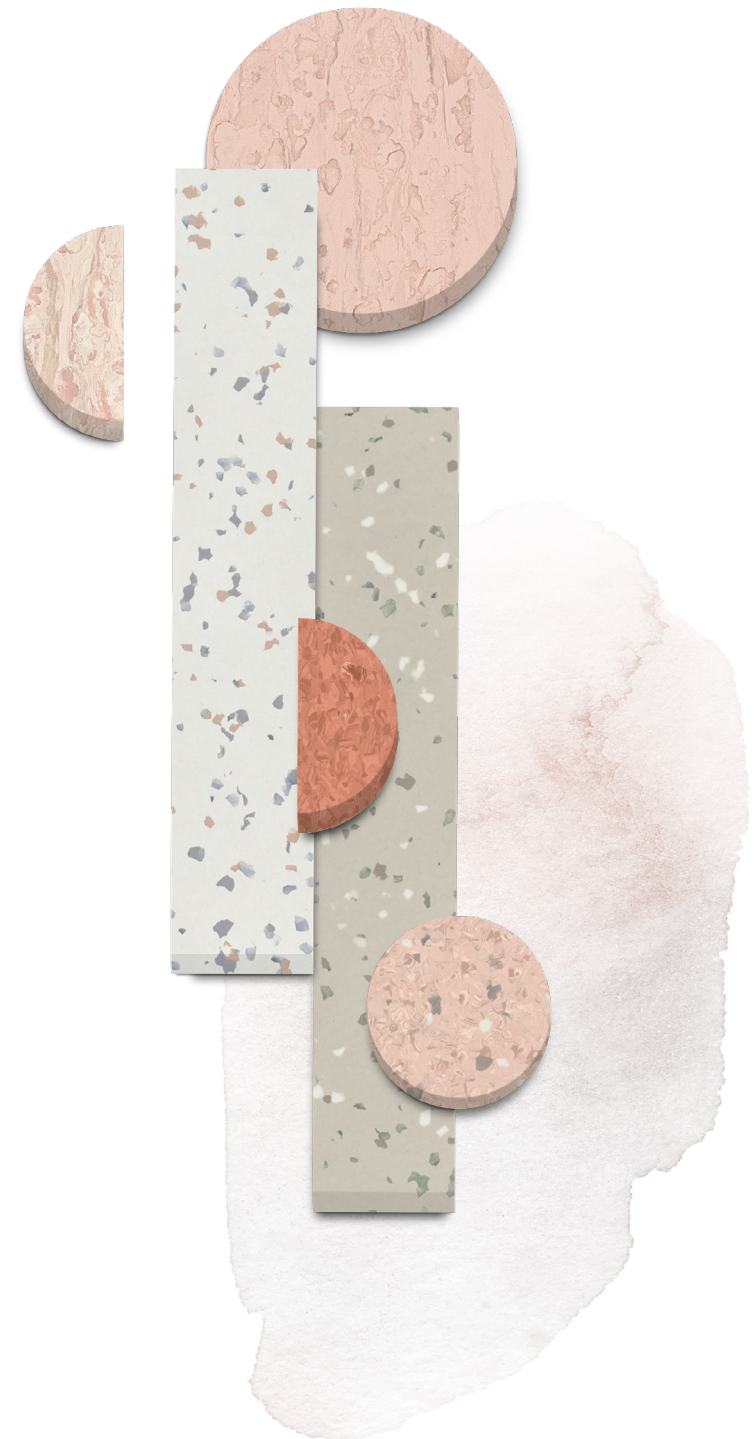

iQ Optima: a complete colour combination with iQ Granit and iQ Eminent

OXID

iQ Collection

															iQ Optima
3242 952	3242 205	3242 990	3242 997	3242 877	3242 926	3242 927	3242 876		3242 833	3242 830	3242 827	3242 828	3242 897	3242 862	
															iQ Eminent
21030 887		21030 885	21030 998		21030 895		21030 999		21030 905						
															iQ Granit
21142 330		21142 325	21142 324	21142 525	21142 457	21142 456	21142 526		21142 458	21142 755	21142 527	21142 329	21142 328	21142 337	

ARGIL

														iQ Optima
3242 977	3242 989	3242 996	3242 834	3242 835	3242 837	3242 838		3242 860	3242 822	21140 823	3242 246	3242 807	3242 245	
														iQ Eminent
21030 870		21030 928		21030 894					21030 939	21030 883	21030 878		21030 879	
														iQ Granit
21142 752	21142 298	21142 320	21142 440	21142 439	21142 438	21142 412		21142 444	21142 322	21142 321	21142 323	21142 528		

iQ Optima: a complete colour combination with iQ Granit and iQ Eminent

LICHEN

iQ Collection

															iQ Optima
															iQ Eminent
															iQ Granit

BASALT

															iQ Optima
															iQ Eminent
															iQ Granit

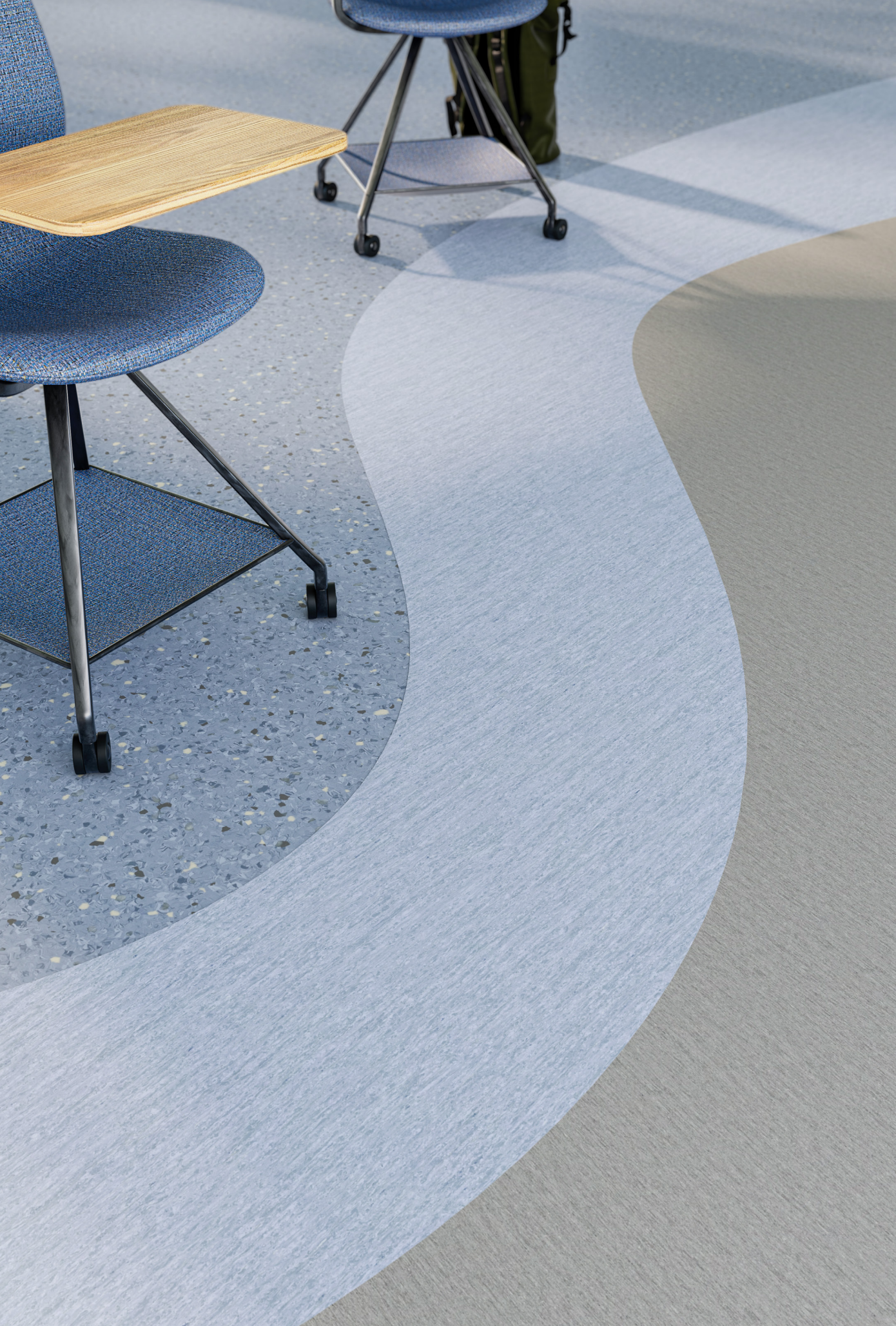

Dementia-friendly design principles are based on the use of adapted patterns, contrast, and colour to make an environment easier to perceive for the elderly, and particularly those with dementia.

Visit our website to find out more about designing dementia-friendly spaces.

What makes iQ Optima a world leading flooring solution?



Amphia Hospital | Breda, Netherlands | iQ Optima, iQ Granit

The bestselling homogeneous vinyl floor in the world for over 40 years, iQ Optima comes with a 10-year warranty, making it a perfect solution for heavy-use settings including educational and healthcare facilities.

The range is designed to help harmonise your spaces, and ensure inclusive design with dementia-friendly options. And the story doesn't stop there, the iQ Optima collection pairs beautifully with our more technical floors, such as **iQ Toro SC** (static-conductive), **iQ Granit SD** (static-dissipative), and **Granit Safe.T** or **Granit Multisafe** (ultra non-slip).

From our factory in Ronneby, Sweden, we have used the very best materials (phthalate and biocide free) to create the very best product that contributes to a circular, sustainable economy.

Learn more about iQ Optima's technical credentials:

Outstanding durability

- Excellent cleanability
- Reliable installation
- Unique iQ dry-buffing surface restoration

True multifunctionality

- Acoustic
- Anti-slip
- Static-conductive/dissipative
- Multi-coloured welding rods

Sustainability at the heart

- Good materials
- Sustainable production
- Off-cut and post use recyclability

Outstanding durability

Excellent cleanability and reliable installation

iQ Optima is fast to install and offers outstanding cleanability. Whether enduring the foot traffic of a busy hospital corridor or the activity of a school assembly hall, its resistance to stains and scratches make it a hygienic choice.



A truly unique **homogeneous 2 mm** construction lasting for **30 years** and more, based on EPD data.

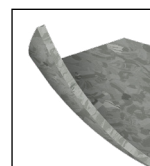

HOMOGENEOUS CONSTRUCTION



iQ Optima's smooth surface and unique surface treatment offers an 'excellent cleanability' result, validated by the Fraunhofer riboflavin test. Additionally it is resistant to disinfectants and antiseptics used in healthcare settings such as quaternary ammoniums, alcohol, bleach, and hydrogen peroxide.

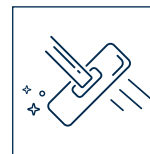

It is an ideal solution for proper **infection protection control**.



iQ Optima **does not favour bacteria growth** (according to ISO 846/C) and does **not contain biocides**.



It can be installed in **ISO 4 cleanrooms** (ISO 14644-1).

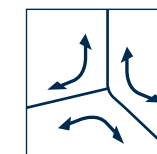

iQ Optima is fully flexible to allow for **perfect coving and a water tight seal from floor to wall**. This makes installation faster and easier.



Outstanding seam strength: joints are perfectly sealed to prevent opening, which stops dirt from getting trapped, gives a watertight finish, and enhances seam strength.



Our technical teams are there to **support your project installation**. Contact your sales representative for more information and training.

Outstanding durability

iQ dry-buffing surface restoration for cleaner, longer-lasting floors

We are the only company on the market to offer a dry surface restoration that keeps floors like new for decades.

What is iQ dry-buffing surface restoration?

iQ dry-buffing surface restoration is a simple and effective flooring maintenance procedure, which, being performed on high-quality iQ products, over and over, brings floors back to their original splendor.

Instead of all kinds of acrylic or polymer re-coating, with the dry-buffing system, the product surface is continuously mechanically restored.

This brings maximum durability in terms of visual and technical properties and keeps floors looking their best for a much longer time.

The primary goal of iQ dry-buffing surface restoration is to smooth out minor scratches, scuffs, or imperfections that naturally develop on the surface over time. It can also help refresh the sheen and lustre of the floor, especially if the finish has become dull.

When should the process be performed?

Dry-buffing should be carried out as soon as a traffic pattern shows up. These are areas which have become worn due to foot traffic and rolling loads over time, which accelerates dirt pick-up and requires more frequent cleaning. Dry-buffing can be performed as many times as deemed necessary.

DRY-BUFFING PROCESS

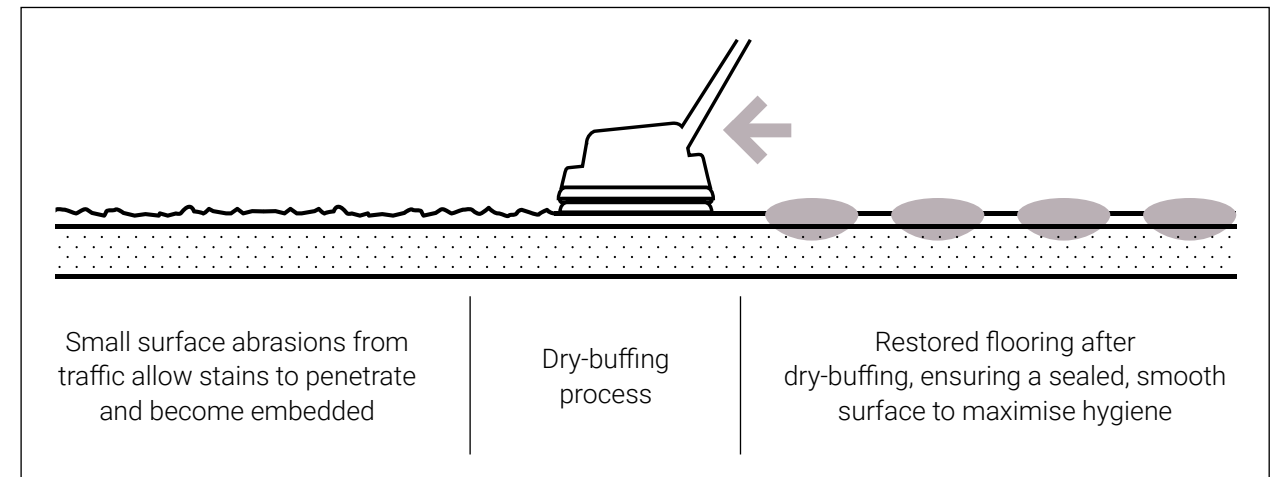

How does dry-buffing work?

Dry-buffing mechanically affects the properties and appearance of the floor surface. Harnessing the power of mechanical friction in a positive manner, high-speed dry-buffing smooths the finish and removes wear patterns while keeping the protective PU surface treatment.

The iQ Surface Restoration is performed dry with Scotch-Brite™ Premium red floor pads (uniform distribution of mineral abrasives throughout every pad) or Twister Green in combination with light high-speed buffing machines above 1000 RPM.

Added benefits

iQ dry-buffing surface restoration stands out because of its minimalistic approach.

From eco-friendly practices to enhanced floor preservation, dry surface restoration offers an alternative that is not only effective but also environmentally and economically sound.

It also helps maintain the longevity of the floor, making the best use of the materials that go into its production, and saving significant costs over time. Consistent dry buffing removes traffic patterns which wear floors down over time.



BENEFITS OF iQ DRY-BUFFING SURFACE RESTORATION

- + No maintenance down-time
- + Lowered water, chemical, and energy consumption
- + No re-coating
- + Lowered maintenance cost (offsets entire cost of the flooring over time)
- + Eco-friendly

True multifunctionality

Tailored to your needs

Acoustic solution



Need to minimise noise? **iQ Optima Acoustic** offers an impact sound reduction of 16 dB. With a 2 mm wear layer and PVC backing, our acoustic solution offers the same durability as our compact.

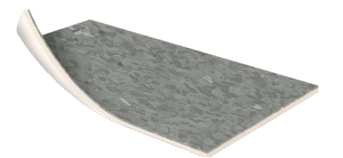

ACOUSTIC PVC BACKING CONSTRUCTION

Anti-slip options



Tread safely for decades with **Granit Safe.T**. This product's unique makeup sees particles embedded throughout its entire construction to make it anti-slip (DIN EN 13845).

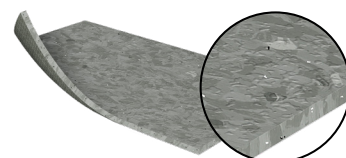

EMBEDDED PARTICLES



Granit Multisafe has a studded anti-slip grip providing a high level of protection for bare feet, even in wet rooms where the floor is covered with soap and water.

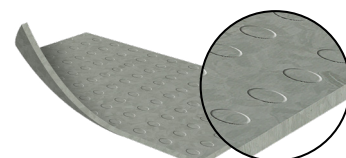

ANTI-SLIP STUDS

Static conductive / dissipative options

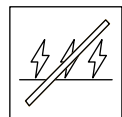

iQ Granit SD has an electrical resistance of $R1 \leq 10^8$ Ohms (EN 1081)

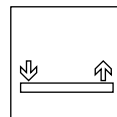

iQ Toro SC has a resistance between $R1 5 \times 10^4$ Ohms and 10^6 Ohms (EN 1081)

Both comply with European standard EN 1815 on electrostatic propensity.

These floor coverings are the best solution for technical spaces. **Conductive fibres are dispersed throughout the product** (physically dissipative instead of chemically), so **the effect will last over its lifespan**. This allows for dry-buffing, so the flooring can keep its lustre. The treatment does not migrate and is not sensitive to humidity.

Both are very easy to install due to their unique static-conductive carbon backing. This eliminates the need for conductive adhesive glue (except over copper strips).

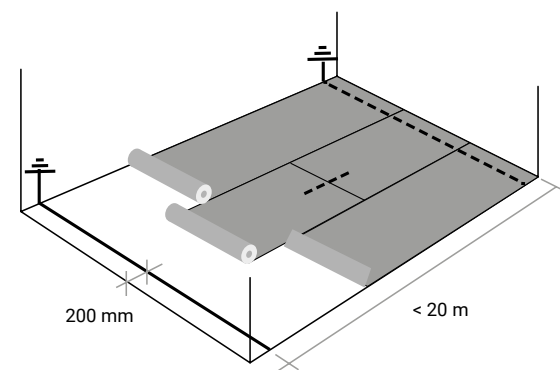

14 colours across the iQ Optima collection have been specially designed to pair with our more technical floors, such as iQ Toro SC, or iQ Granit SD.

iQ Optima Acoustic

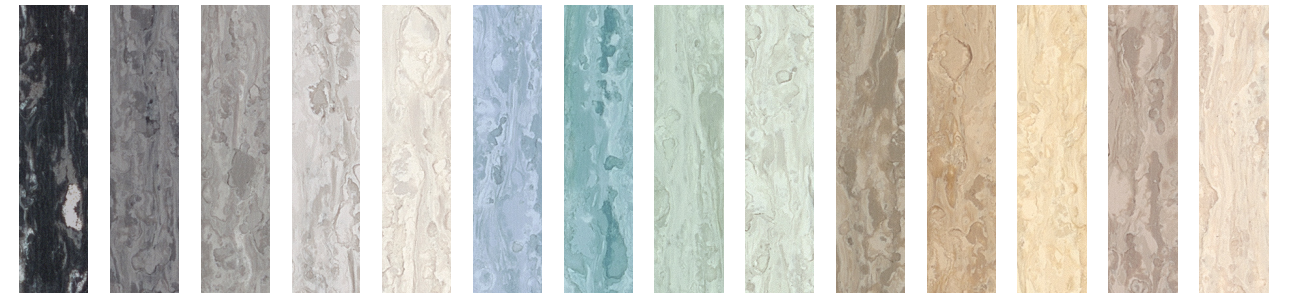

3242 845 3242 866 3242 762 3242 872 3242 760 3242 851 3242 848 3242 843 3242 841 3242 807 3242 823 3242 822 3242 828 3242 827

iQ Toro SC

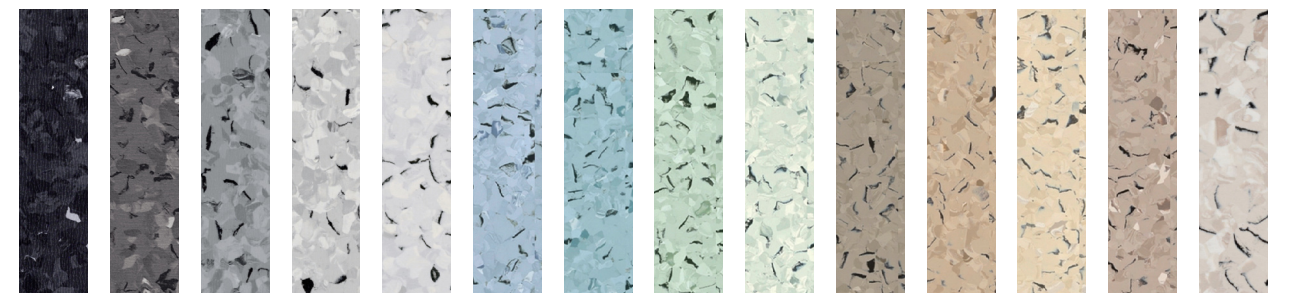

3093 103 3093 578 3093 102 3093 101 3093 100 3093 960 3093 961 3093 966 3093 959 3093 955 3093 956 3093 957 3093 958 3093 104

iQ Granit SD

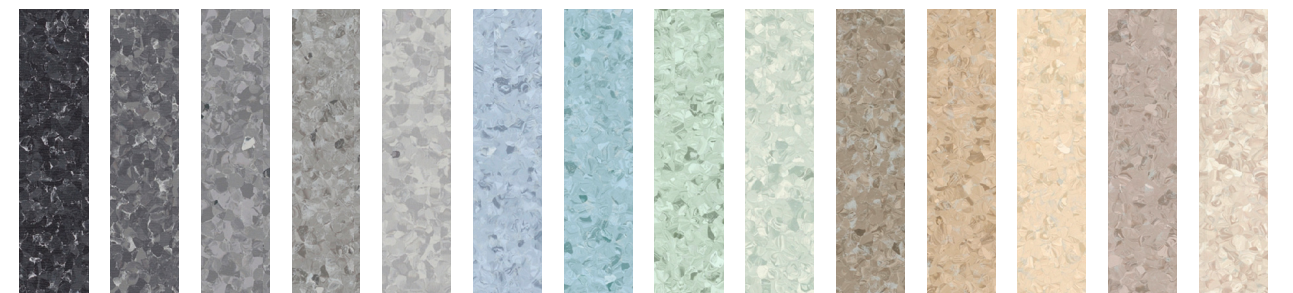

3096 953 3096 950 3096 949 3096 948 3096 395 3096 476 3096 980 3096 994 3096 475 3096 436 3096 467 3096 468 3096 474 3096 954

Granit Safe.T

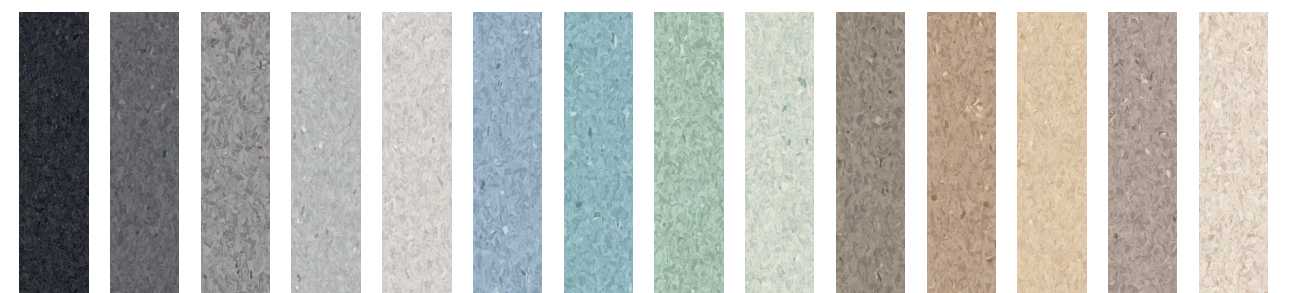

21153 506 21153 505 21153 504 21153 503 21153 502 21153 516 21153 517 21153 518 21153 514 21153 508 21153 509 21153 511 21153 513 21153 512

Sustainability at the heart

Circular innovation to reduce our carbon footprint

At Tarkett, we're committed to a sustainable, circular economy that creates value for everyone. We want to close the loop on waste, preserve natural resources, and reduce our impact on climate change.

Made in Sweden, iQ Optima is made with an average of 25% recycled material, is recyclable (installation off-cuts and post-use), and is produced using 100% renewable energy. Our iQ ranges are an impactful choice, lasting for 30 years or more and featuring technology that enables simple maintenance and quick repair. While iQ Optima contains an average of 25% recycled content, we aim make this 30% on all our products by 2030. To achieve this goal, our

iQ ReStart® recycling scheme, collects, processes, and places post-use floors back into the production cycle to create new floors. This means our clients can work towards green building labels like LEED, WELL, and BREEAM, with 1 m² of recycled iQ homogeneous vinyl saving 11.8 kg CO₂eq/m².

The way to better floors

The pursuit of 'always more' is threatening our planet, and so we need to find a way to deliver more with less. At the heart of its eco design story, iQ Optima is about doing more with less. Less waste, lower emissions, greater wellbeing, more proof.

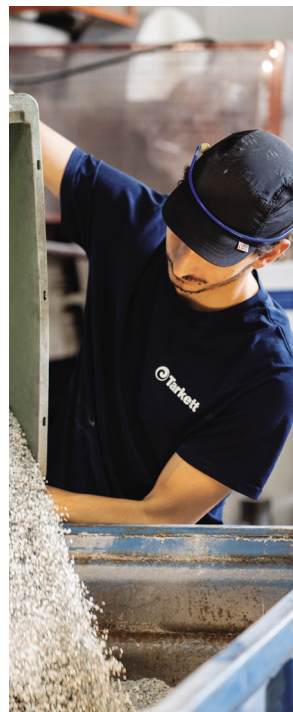

* Assessment validated by ivl, the Swedish environmental research institute.

iQ Optima has been created within the principles of a circular economy. Close the loop on waste and nurture your sustainable impact.

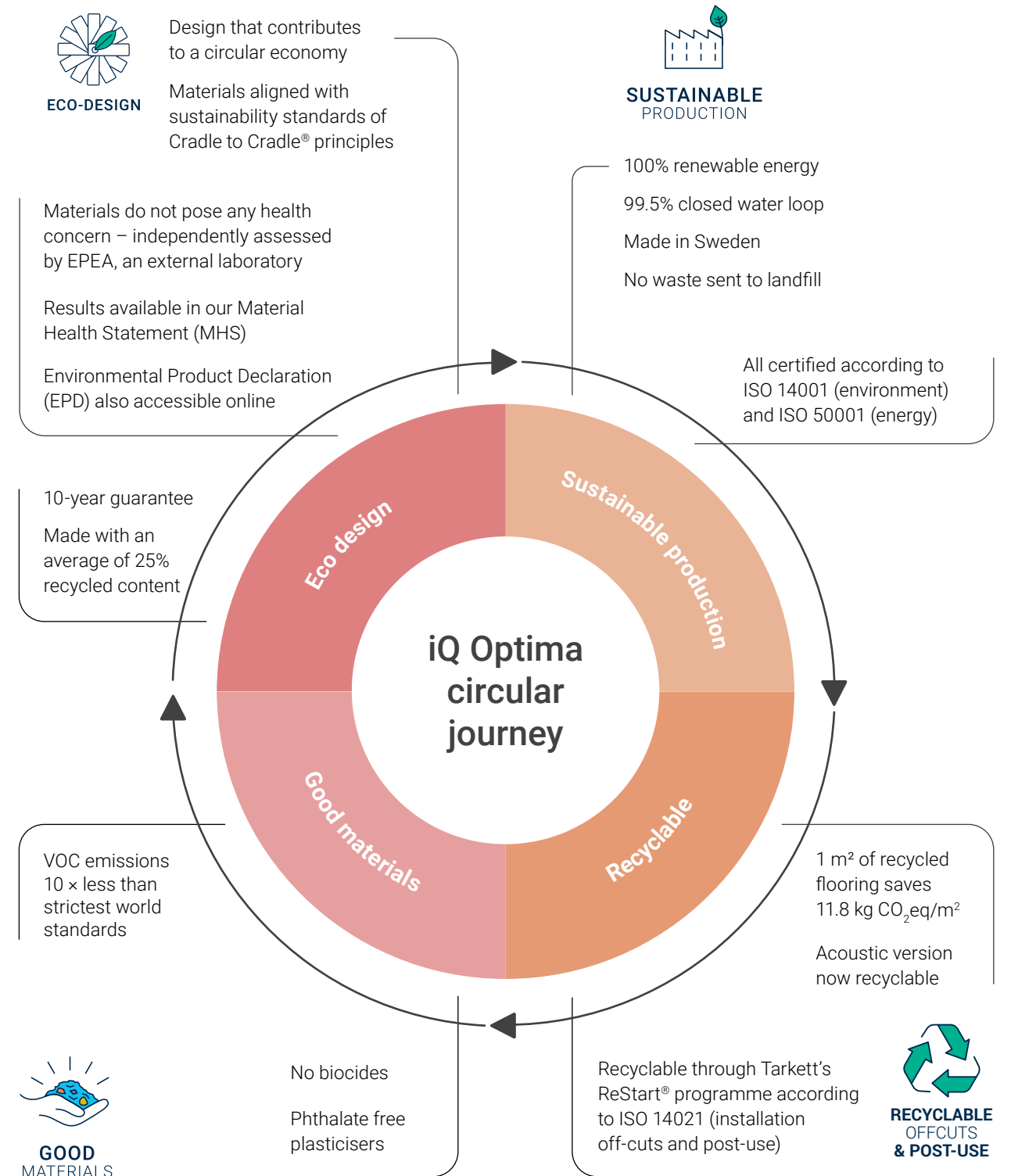

iQ Optima Full Range

iQ Optima		iQ Optima Acoustic	Welding rod		NCS	LRV	iQ Toro SC	iQ Granit SD	Granit Safe.T	Granit Multisafe
references	references	references	unicolour	multicolour	codes	%	references	references	references	references
3242 201	3217 201	21171 201	1287 836	1290 355	S 6502-B	15	-	-	-	-
3242 205	3217 205	21171 205	1287 838	1290 359	S 1002-Y	72	-	-	-	-
3242 242	3217 242	21171 242	1287 006	1290 340	S 4500-N	30	-	-	-	-
3242 245	3217 245	21171 245	1287 279	1290 085	S 2002-Y	56	-	-	-	-
3242 246	3217 246	21171 246	1292 319	1290 290	S 2005-Y30R	56	-	-	-	-
3242 760	3217 760	21171 760	1287 411	1290 369	S 1500-N	65	3093 100	3096 395	21153 502	-
3242 762	3217 762	21171 762	1287 692	1290 170	S 4502-B	29	3093 102	3096 949	21153 504	21154 896
3242 799	3217 799	21171 799	1287 548	1290 192	S 7500-N	11	-	-	-	-
3242 807	3217 807	21171 807	1287 341	1290 180	S 4005-Y20R	33	3093 955	3096 436	21153 508	-
3242 822	3217 822	21171 822	1287 797	1290 329	S 1510-Y30R	61	3093 957	3096 468	21153 511	21154 469
3242 823	3217 823	21171 823	1287 391	1290 143	S 3010-Y30R	41	3093 956	3096 467	21153 509	-
3242 827	3217 827	21171 827	1287 698	1290 452	S 1505-Y50R	63	3093 104	3096 954	21153 512	-
3242 828	3217 828	21171 828	1287 233	1290 343	S 3005-Y50R	40	3093 958	3096 474	21153 513	21154 470
3242 830	3217 830	21171 830	1292 442	1290 268	S 1510-Y50R	59	-	-	-	-
3242 833	3217 833	21171 833	1287 216	1290 441	S 3020-Y60R	34	-	-	-	-
3242 834	3217 834	21171 834	1287 359	1290 428	S 1050-Y20R	55	-	-	-	-
3242 835	3217 835	21171 835	1287 582	1290 206	S 1020-Y20R	65	-	-	-	-
3242 837	3217 837	21171 837	1287 442	1290 447	S 2020-G70Y	52	-	-	-	-
3242 838	3217 838	21171 838	1287 745	1290 450	S 4020-G30Y	27	-	-	-	-
3242 839	3217 839	21171 839	1287 951	1290 437	S 3040-G20Y	28	-	-	-	-
3242 841	3217 841	21171 841	1287 323	1290 449	S 2005-G	54	3093 959	3096 475	21153 514	21154 471
3242 843	3217 843	21171 843	1287 860	1290 442	S 2010-G	52	3093 966	3096 994	21153 518	-
3242 845	3217 845	21171 845	1291 845	1290 034	S 8502-B	6	3093 103	3096 953	21153 506	-
3242 848	3217 848	21171 848	1287 509	1290 398	S 2020-B10G	44	3093 961	3096 980	21153 517	21154 473
3242 851	3217 851	21171 851	1287 803	1290 425	S 2020-R90B	44	3093 960	3096 476	21153 516	-
3242 853	3217 853	21171 853	1292 388	1290 022	S 3500-N	39	-	-	-	-
3242 855	3217 855	21171 855	1287 804	1290 336	S 3030-R90B	28	-	-	-	21154 472
3242 860	3217 860	21171 860	1287 039	1290 066	S 2010-Y20R	52	-	-	-	-
3242 862	3217 862	21171 862	1291 862	1290 025	S 1002-Y50R	74	-	-	-	21154 123
3242 864	3217 864	21171 864	1287 412	1290 029	S 2500-N	50	-	-	-	-
3242 866	3217 866	21171 866	1287 842	1290 026	S 6502-B	15	3093 578	3096 950	21153 505	21154 901
3242 867	3217 867	21171 867	1287 335	1290 165	S 4040-R90B	15	-	-	-	-
3242 869	3217 869	21171 869	1287 953	1290 439	S 6020-R90B	11	-	-	-	-
3242 871	3217 871	21171 871	1287 522	1290 120	S 1502-B	63	-	-	-	-
3242 872	3217 872	21171 872	1287 523	1290 121	S 2500-N	50	3093 101	3096 948	21153 503	-
3242 873	3217 873	21171 873	1287 524	1290 122	S 3502-Y	38	-	-	-	-
3242 874	3217 874	21171 874	1287 840	1290 338	S 5502-Y	22	-	-	-	-
3242 876	3217 876	21171 876	1287 952	1290 438	S 4030-R	18	-	-	-	-
3242 877	3217 877	21171 877	1287 463	1290 241	S 2070-Y90R	15	-	-	-	-
3242 886	3217 886	21171 886	1291 609	1290 049	S 2002-Y20R	59	-	-	-	-
3242 897	3217 897	21171 897	1287 170	1290 203	S 4005-Y50R	31	-	-	-	-
3242 926	3217 926	21171 926	1287 954	1290 453	S 1015-Y80R	62	-	-	-	-
3242 927	3217 927	21171 927	1287 894	1290 384	S 2040-Y60R	35	-	-	-	-
3242 946	3217 946	21171 946	1287 411	1290 369	S 1500-N	65	-	-	-	-
3242 947	3217 947	21171 947	1287 524	1290 122	S 3502-G50Y	38	-	-	-	-
3242 952	3217 952	21171 952	1287 545	1290 448	S 4502-Y80R	29	-	-	-	-
3242 977	3217 977	21171 977	1287 870	1290 451	S 6005-Y20R	18	-	-	-	-
3242 983	3217 983	21171 983	1287 678	1290 444	S 2010-R90B	52	-	-	-	-
3242 987	3217 987	21171 987	1291 954	1290 202	S 2010-G30Y	53	-	-	-	-
3242 989	3217 989	21171 989	1287 685	1290 443	S 2010-Y20R	52	-	-	-	-
3242 990	3217 990	21171 990	1287 943	1290 445	S 2010-Y70R	49	-	-	-	-
3242 993	3217 993	21171 993	1287 523	1290 120	S 2005-R90B	55	-	-	-	-
3242 995	3217 995	21171 995	1287 279	1290 446	S 2005-G60Y	55	-	-	-	-
3242 996	3217 996	21171 996	1287 415	1290 422	S 2005-Y30R	56	-	-	-	-
3242 997	3217 997	21171 997	1291 981	1290 440	S 1510-Y80R	58	-	-	-	-

TECHNICAL DATA	STANDARD	iQ OPTIMA	iQ OPTIMA ACOUSTIC
Classification	Norm	Tarkett Value	Tarkett Value
Product type	ISO 10581	Homogeneous vinyl floor covering	-
	ISO 11638	-	Homogeneous vinyl flooring with foam interlayer
Wear layer binder content	ISO 10581	Type I	-
	ISO 11638	-	Type II
Commercial classification	ISO 10874	34 Very Heavy	34 Very Heavy
Industrial classification	ISO 10874	43 Heavy	42 General
Technical Characteristics	Norm	Tarkett Value	Tarkett Value
Surface treatment		New iQ PUR	New iQ PUR
Total thickness	ISO 24346	2 mm	3.15 mm
Wear layer thickness	ISO 24340	2 mm	2 mm
Total weight	ISO 23997	2650 g/m ²	3300 g/m ²
Performance for CE Marking	Norm	Tarkett Value	Tarkett Value
Declaration of performance	EN 14041	0019-0003-DoP-2013-07	0019-0082-DoP-2023-05
Reaction to fire	EN ISO 13501-1 EN ISO 9239-1 EN ISO 11925-2	B _e -s1 ≥ 8 kW/m ² Pass	B _e -s1 ≥ 8 kW/m ² Pass
Static electrical propensity	EN 1815	Antistatic (≤ 2 kV)	Antistatic (≤ 2 kV)
Thermal resistance	EN 12667	Approx. 0.010 m ² · K/W	Approx. 0.010 m ² · K/W
Slip resistance	EN 13893	Class DS (μ ≥ 0.30)	Class DS (μ ≥ 0.30)
Technical Performances	Norm	Tarkett Value	Tarkett Value
Residual indentation	EN ISO 24343-1	Required value: ≤ 0.10 mm Best measured value*: 0.02 mm	Required value: ≤ 0.20 mm Best measured value*: 0.10 mm
Impact sound reduction	EN ISO 717/2	-	16 dB
Slip resistance	DIN 51130 BS 7976-2	R9 Low risk of slip	R9 Low risk of slip
Curl resistance to heat	EN ISO 23999	≤ 8 mm for rolls / ≤ 2 mm for tiles	-
Clean room test	ISO 14644-1	ISO class 4	-
Castor chair	ISO 4918	Suitable	Suitable
Colour fastness to light	EN ISO 105-B02	≥ 7	≥ 7
Dimensional stability	EN ISO 23999	Average measured value: ≤ 0.40% for rolls Average measured value: ≤ 0.25% for tiles	Average measured value: ≤ 1.00% for rolls -
Ease of decontamination	ISO 8690 - DIN 25415	Excellent	Excellent
Chemical resistance	EN ISO 26987	Excellent resistance	Excellent resistance
Bacteria resistance	ISO 846 Part C	Does not favour growth	Does not favour growth
Riboflavin test	Fraunhofer method	Class 0: Excellent	Class 0: Excellent
Underfloor heating		Suitable (subfloor temperature maximum 27°C)	Suitable (subfloor temperature maximum 27°C)
Wetroom approval	EN 13553 Annex A	Watertight	-
Seam strength	EN 684	Average value: ≥ 400 N / 50 mm Individual values: ≥ 180 N / 50 mm	Average value: ≥ 240 N / 50 mm Individual values: ≥ 180 N / 50 mm
Sustainability Performances	Norm	Tarkett Value	Tarkett Value
Recyclability through ReStart®		Recyclable offcuts and post-use	Recyclable offcuts and post-use
Recycled content		25.5%	22%
Carbon footprint (Cradle-to-Gate, EPD Modules A1-A3)		5.24 kg CO ₂ eq/m ²	In progress
Total carbon footprint (EPD Modules A-D, incl. recycling scenario)		3.83 kg CO ₂ eq/m ² /year	In progress
Total VOC emissions	EN 16516	Platinum (≤ 10 μg/m ³)	Platinum (≤ 10 μg/m ³)
Formaldehyde emission class		E1	E1
Dimensions and Designs	Norm	Tarkett Value	Tarkett Value
Roll		2 × 25 m	1.95 × 25 m
Tile		Tile 610 × 610 mm - 14 tiles: 5.2 m ² /box - 40 boxes/pallet	-
Number of designs available		55	55

■ **WESTERN EUROPE:** Austria: Tarkett Holding GmbH, Niederlassung Wien – Tel. +43 1 47 88 062 ■ **Belgium:** Tarkett Belux Sprl – Tel. +32 52 26 24 11 ■ **Denmark:** Tarkett A/S – Tel. +45 43 90 60 11 ■ **Finland:** Tarkett Oy – Tel. +358 9 4257 9000 ■ **France:** Tarkett SAS – Tel. +33 1 41 20 42 49 ■ **Germany:** Tarkett Holding GmbH – Tel. +49 621 68172 300 ■ **Greece:** Tarkett Monoprosopi Ltd – Tel. +30 210 6745 340 ■ **Italy:** Tarkett S.p.A. – Tel. +39 0744 7551 ■ **Luxembourg:** Tarkett GDL SA – Tel. +352 949 211 8804 ■ **Netherlands:** Tarkett BV – Tel. +31 416 685 491 ■ **Norway:** Tarkett AS – Tel. +47 32 20 92 00 ■ **Portugal:** Tarkett SA – Tel. +351 21 427 64 20 ■ **Spain:** Tarkett Floors S.L – Tel. +34 91 358 00 35 ■ **Sweden:** Tarkett Sverige AB – Tel. +46 771 25 19 00 ■ **Switzerland:** Tarkett Holding GmbH – Tel. +41 043 233 79 24 ■ **Turkey:** Tarkett Aspen – Tel. +90 212 213 65 80 ■ **United Kingdom:** Tarkett Ltd – Tel. +44 (0) 1622 854 040 ■ **EASTERN EUROPE: Baltic Countries:** Tarkett Baltics: Tel. +370 37 262 220 ■ **Czech Republic:** Tarkett org. složka – Tel. +420 271 001 600 ■ **Hungary:** Tarkett Polska SP Z.O.O. magyarországi fióktelepe – Tel. +36 1 437 8150 ■ **Poland:** Tarkett Polska Sp. z o. o. – Tel. +48 22 16 09 231 ■ **Russian Federation:** ZAO Tarkett RUS – Tel. +7 495 775 3737 ■ **Slovakia:** Tarkett Polska, organizačná zložka – Tel. +421 2 48291 317 ■ **South East Europe:** Tarkett SEE – Tel. +381 21 7557 649 (44) 569 12 21 ■ **Ukraine:** Tarkett UA – Tel. +38 (0) 44 35 45 621 ■ **ASIA AND OCEANIA: Australia:** Tarkett Australia Pty Ltd – Tel. +61 2 88 53 12 00 ■ **China:** Tarkett Floor Covering (Shanghai) Co. Ltd. – Tel. +86 (21) 60 95 68 38 ext 841 ■ **North East Asia:** Tarkett Hong Kong Limited – Tel. +852 2511 8716 ■ **India:** Tarkett Flooring India Pvt. Ltd. – Bangalore – Tel. +91 80 4130 3793 – New Delhi – Tel. +91 11 4352 4073 – Mumbai – Tel. +91 22 2648 8750 ■ **South East Asia:** Tarkett Flooring Singapore Pte. Ltd. – Tel. +65 6346 1585 ■ **AFRICA: Tarkett International:** Tel. +33 1 41 20 41 01 ■ **MIDDLE EAST: Tarkett Middle East:** Tel. +961 1 51 3363/4 ■ **Israel:** Tarkett International: Tel. +33 1 41 20 41 01 ■ **NORTH AMERICA: USA:** Tarkett Inc. – Tel. +1 713 869 5811 / Johnsonite – Tel. +1 440 543 8916 ■ **Canada:** Tarkett Inc. – Tel. +1 450 293 173 ■ **LATIN AMERICA: Brazil:** Tarkett – Tel. 55 12 3954 7108 ■ **Argentina – Chile – Uruguay:** Tarkett Latam Mercosur – Tel. +54 11 47 08 07 72 / +54 9 11 44 46 88 82 ■ **Bolivia – Colombia – Ecuador – Panama – Paraguay – Peru – Trinidad and Tobago – Venezuela:** Tarkett – Tel. +55 11 9 8410 9310 / +55 11 95494 0069 ■ **Mexico /Central America:** Tarkett Latam Mexico – Tel. +55 11 98410 9310

The designs and photos used in this brochure are for illustration purposes only. They are not contractual images and do not stand for product recommendation.
Design & Photo: evo

